

Name: Fora S/50 Outdoor

Design: Alex Fernández Camps / Gonzalo Milà / 2010

Typology: Pendant lamp







Environment: Outdoor

Technical description:

Outdoor pendant lamp releasing light through a frosted medium density, UV protected polyethylene globe, shielded by weaved synthetic polyethylene fiber lamp shade. Lamp shade is available in natural white and brown graphite. Canopy is aluminum, coated with anti-corrosive, cathaphoresis treatment to provide comprehensive protection against all weather conditions in accordance with IP 55 rating. Electrical cord is encased with protective neoprene. Height can be adjusted by tensor wire. (IP 55).



Lamps description

-  Grounding: compulsory
-  2 x 20 W E26 Triple CFL
-  2 x 10 W E26 A19 LED
- Voltage: 120V~60Hz
-  1 Box 23.62 x 23.62 x 15.75 inches
- Vol.: 5.0853 ft³
- Weight: 14.33 lbs
- Certifications:   IP-55
-  Photometrics made according to the position the lights are shown in the catalogue and price list.

Ref Finishings

Ref	Finishings
SETS:	
4130301U	Natural White
P-695C	Light Beige
4130303U	Brown Graphite
P-696C	Brown
All Bover's synthetic fiber collection are recyclable and non-toxic for environmental sustainability.	
Lampshade 19.69" x 11.81" Synthetic Polyethylene Fiber, aluminum frame. (Operating temperature: -70°C to +70°C)	
Light source is protected by polyethylene globe of medium density and UV protection. (Operating temperature: -40°C to +70°C)	
Not Customizable	

Measures

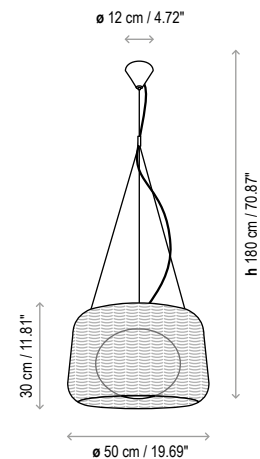

Fora A/01 Outdoor

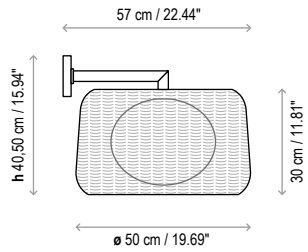

Fora PF/50 Outdoor

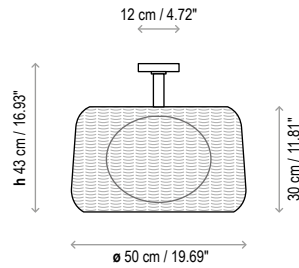

Fora S/50 Outdoor

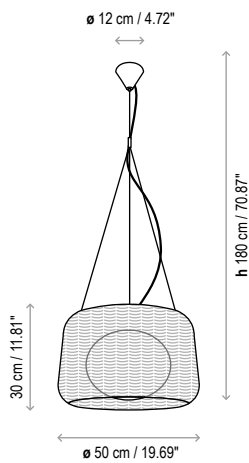

Fora S/90 Outdoor

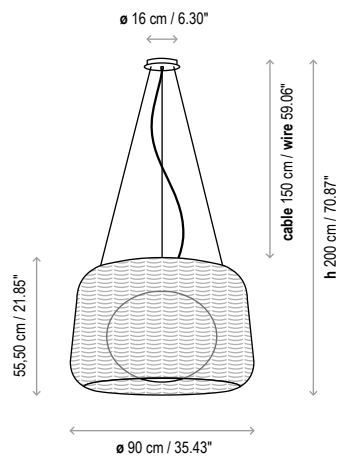

Fora M/70 Outdoor

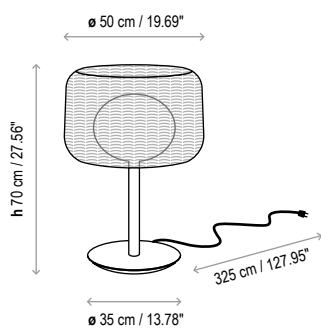

Fora P/165 Outdoor(Concrete Base)

